

DOMETIC FRIGO 2018

# FULLY INTEGRATED COOLING SYSTEMS

FOR REFRIGERATED VEHICLES

Mobile living made easy.

 **DOMETIC**

# DOMETIC FRIGO: FOR REFRIGERATED AND DEEP-FREEZE VEHICLES

- Mobile and stationary refrigeration for temperature controlled transport
- For load compartments up to 18 m<sup>3</sup>
- No roof-mounted parts
- Engineered in Germany 

## **NEW: DOMETIC FRIGO DC!**

Our new innovative fully electrical refrigerated system. Lighter, less power consumption and faster to install.

**Find out more on page 6.**





---

## CONTENTS

<b>Introduction</b>	<b>04</b>
<b>NEW! Dometic Frigo DC</b> – Fully electrical system	<b>06</b>
<b>Dometic Frigo</b> – Belt driven system	<b>08</b>
<b>Product selection</b>	<b>10</b>
<b>Approvals</b>	<b>14</b>

## DOMETIC ON THE WEB

Here's where you can find the complete Dometic range, with detailed information about all products. Plus, interesting facts about our company and download links for all our catalogues.

**DOMETIC.COM**

# DOMETIC FRIGO COOLING SYSTEMS

## TEAMWORK OF EXPERTS

With a track record of over 40 years, Dometic is one of the most experienced manufacturers of cooling systems for refrigerated and deep-freeze vehicles. The Dometic Frigo cooling concept was created in cooperation with TWK Karlsruhe, Germany's leading institute for optimised vehicle cooling systems. It covers all industry demands placed on retrofit cooling systems. We exclusively use first-class quality components from renowned specialist manufacturers, and optimise them for the best performance.

**Dometic Frigo was designed as a modular system. Universal basic components give installers all the flexibility they need.**

## THE NEW GENERATION - FULLY ELECTRICAL

The new Dometic Frigo DC is our answer to new generation vehicles where space in the engine compartment is limited and direct-drive compressor installation is often impossible. Our engineers have found a smart solution: We use an electrical compressor with integrated inverter which allow us to control the RPM of the compressor according the required cooling performance and available energy. Variable speed compressor giving constant temperature control, higher performance and lower power consumption.

Read more on this on page 6.

## WHAT ABOUT THE ORIGINAL DOMETIC FRIGO?

Good news for the friends of our well proven Dometic Frigo system: the **components continue to be available and can be found on page 8.**



## FULLY INTEGRATED COOLING SYSTEMS – CUSTOMISED TO SUIT THE FREIGHT AND THE VEHICLE

The transport of temperature-sensitive freight is a demanding logistic task subject to strict legal regulations. It calls for a vehicle that is equipped to take perishable foodstuffs, medicines or blood donations from one place to another with one-degree accuracy. The modular Dometic Frigo system provides highly reliable cooling solutions for all commonly used refrigerated vehicles. The entire refrigeration system is integrated in the vehicle where it takes up little space – and without the roof-mounted structure you typically have with other manufacturers' systems.

It takes just a few easy steps to create a customised precision cooling system. You start by specifying the type of vehicle, the size of the load compartment and the required temperature conditions. We then put together the modules to suit your specifications. If required, we add optional features such as a stationary cooling system to be operated from the control panel.



# DOMETIC FRIGO DC FULLY ELECTRICAL SYSTEM

An innovative fully integrated electrical system, the Dometic Frigo DC 2500 and Dometic Frigo DC 3500 are faster to install, use less power and are completely independent from the engine.

EVAPORATOR FITS TO ROOF INSIDE COOLING AREA.



**NEW!**



COMBINED COMPRESSOR-CONDENSER-UNIT FITS UNDER THE VEHICLE INTO THE SPAREWHEEL COMPARTMENT

**FULLY INTEGRATED  
ELECTRICAL  
SYSTEM**

**DOMETIC FRIGO DC  
IS INDEPENDENT  
FROM BELT DRIVE, VEHICLE TYPE  
AND ENGINE TYPE**

**LIGHT WEIGHT!**  
Only 43 kg Dometic Frigo DC 2500 and  
47 kg Dometic Frigo DC 3500  
maximum for the complete system

# NEW! DOMETIC FRIGO DC – FULL INTEGRATED ELECTRICAL REFRIGERATION SYSTEM

## HIGH FLEXIBLE TO VEHICLE SETUP





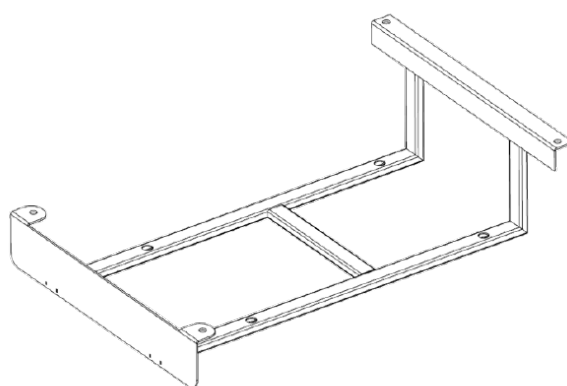

Today's compact van models offer little space for retrofitting a transport cooling systems. Quite often, it is impossible to integrate a belt-driving compressor in the engine compartment. The new generation Dometic Frigo DC systems solve this problem in a smart way. The compressor and the condenser are combined in a compact unit which is fitted in the spare wheel compartment. Like with all Dometic Frigo systems, the evaporator is mounted to the ceiling of the cargo hold.



## DOMETIC FRIGO DC ADAPTER KITS FOR FAST AND EASY INSTALLATION

Our vehicle-specific Dometic Frigo DC adapter kits allow fast and easy installation of the compressor-condenser unit. Available for the most common vans. Contact your local dealer for more information.

## DRIVING MODE COOLING PERFORMANCE

NEW! Dometic Frigo DC	30 °C Ext  			Air flow volume m <sup>3</sup> /h	Power consumption A	Dimensions Evaporator mm (W/H/D)	Total weight system kg
	Driving cooling						
	0 °C	+7 °C	+12 °C				
 DC 2500	1,030 W	1,325 W	1,565 W	780	68*	660 x 157 x 500	43
 DC 3500	1,125 W	1,445 W	1,670 W	1,140	85*	900 x 157 x 500	47
<b>Refrigerant</b>	<b>R 134a</b>						

Vehicle requirements: the vehicle must have minimum a 125 A alternator and a 90 A/h battery.  
(Data for driving mode, stationary mode varies) \*For outside temperature 30 °C and 0 °C inside temperature (according ATP)

# DOMETIC FRIGO DC – THE SMARTEST AND EASIEST COOLING SYSTEM

- Combined compressor and condenser unit fitted in the spare wheel compartment giving faster and easier installation
- Variable speed compressor giving constant temperature control, higher performance and lower power consumption
- As no installation is required in the engine compartment it can be fitted to most vehicle
- Easy to service and maintain – less components, beltless compressor
- Integrated hotgas defrost function (serial)

- Intelligent compressor control unit which controls the RPM of the compressor and condenser fan according available energy (battery protection) and cooling performance requirement.
- Patented Power Management
- Approved according to automotive standards
- Easy to upgrade with stand-by cooling (battery charger and cable kit)

For detailed information about the Dometic Frigo modular system, please refer to the Dometic Frigo price and programme overview.

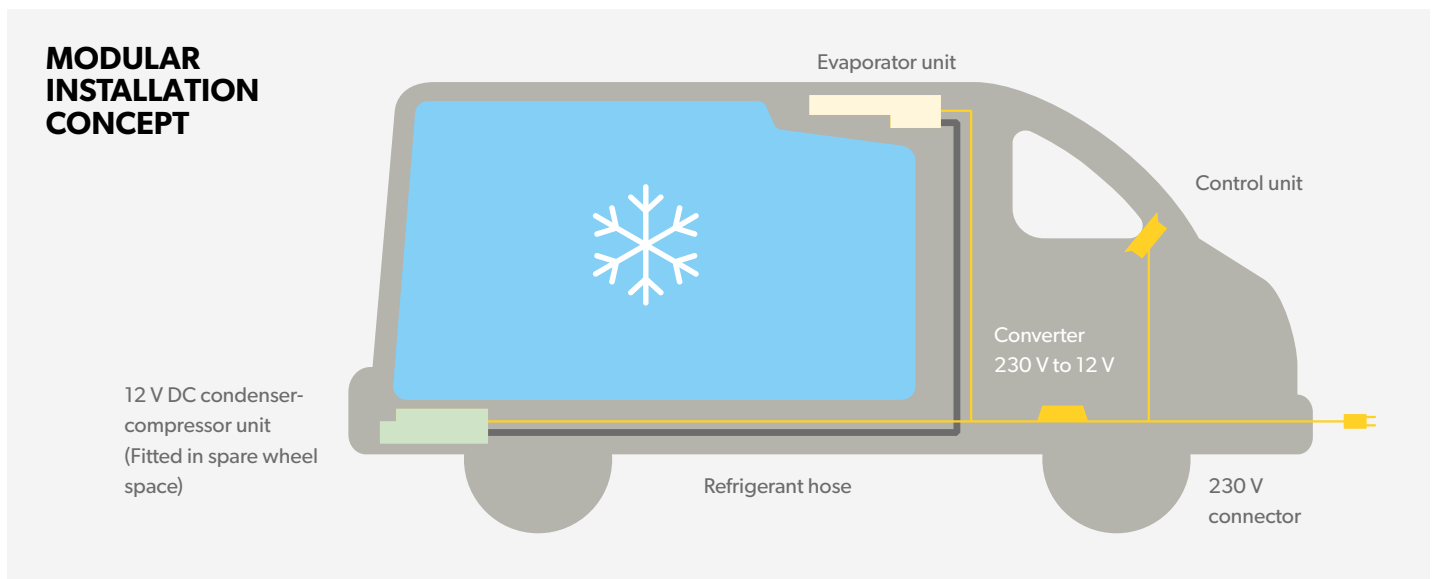

## DOMETIC FRIGO DC OVERVIEW

**EVAPORATOR DC 2500**



**COMPRESSOR-CONDENSER UNIT**



**HOSE, 4 M**



**OPTIONAL**

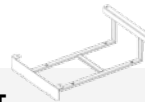

**VEHICLE ADAPTER KIT, STAND-BY KIT**

**EVAPORATOR DC 3500**



**COMPRESSOR-CONDENSER UNIT**



**HOSE, 6 M**



**OPTIONAL**

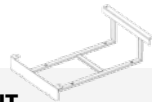

**VEHICLE ADAPTER KIT, STAND-BY KIT**

# DOMETIC FRIGO – BELT DRIVEN SYSTEM



Dometic Frigo refrigeration systems comprise several components, some of which are available as options. The modular concept allows easy customizing for refrigerated and deep-freeze applications. Reliable cooling at constant temperatures can be achieved for load compartment volumes up to 18 m<sup>3</sup>. Regardless of whether it's long distance or local distribution, continuous cooling is guaranteed at all times.

You start with selecting the right size of evaporator, then you add the matching condenser and compressor. All in all, it will take only 8 to 12 hours to install the three basic components.

### Our tip for deep-freeze applications

The Dometic Frigo DC kit includes all special components you need: hot gas defrosting for the evaporator and condensation drain, a low-pressure switch, and an oil separator.



## DRIVING MODE – REFRIGERATION R 134A

Dometic Frigo	30 °C Ext  			Air flow volume	Power consumption
	0 °C	+ 6 °C	+ 12 °C		
	Driving cooling			m <sup>3</sup> /h	A
2500	1,752 W	2,107 W	2,524 W	780	22 A
3500	2,385 W	2,888 W	3,452 W	1,140	27 A
4500	2,454 W	3,051 W	3,589 W	1,560	31 A
Refrigerant	R 134a				

(Data for driving mode, stationary mode varies)

For cargo rooms up to 18 m<sup>3</sup>

## DRIVING MODE – DEEP-FREEZE R 404A

Dometic Frigo	30 °C Ext  			Air flow volume	Power consumption
	0 °C	-10 °C	-20 °C		
	Driving cooling			m <sup>3</sup> /h	A
2500	2,394 W	1,797 W	1,034 W	780	22 A
3500	2,496 W	2,016 W	1,334 W	1,140	27 A
4500	2,567 W	2,062 W	1,283 W	1,560	31 A
Refrigerant	R 404a				

(Data for driving mode, stationary mode varies)



# MODULAR SYSTEM FOR EASY CUSTOMIZING

- Internal assembly of the evaporator – no impact on the appearance or the aerodynamic properties of the vehicle
- Nothing on the roof – no risk of damage when driving into underground car parks
- Safer when having to make sudden movements as the vehicle's centre of gravity is not changed

- No need to cut into the roof trusses or sheet panel – the chassis' torsional stability and anti-corrosion properties are preserved

For detailed information about the Dometic Frigo modular system, please refer to the Dometic Frigo price and programme overview.

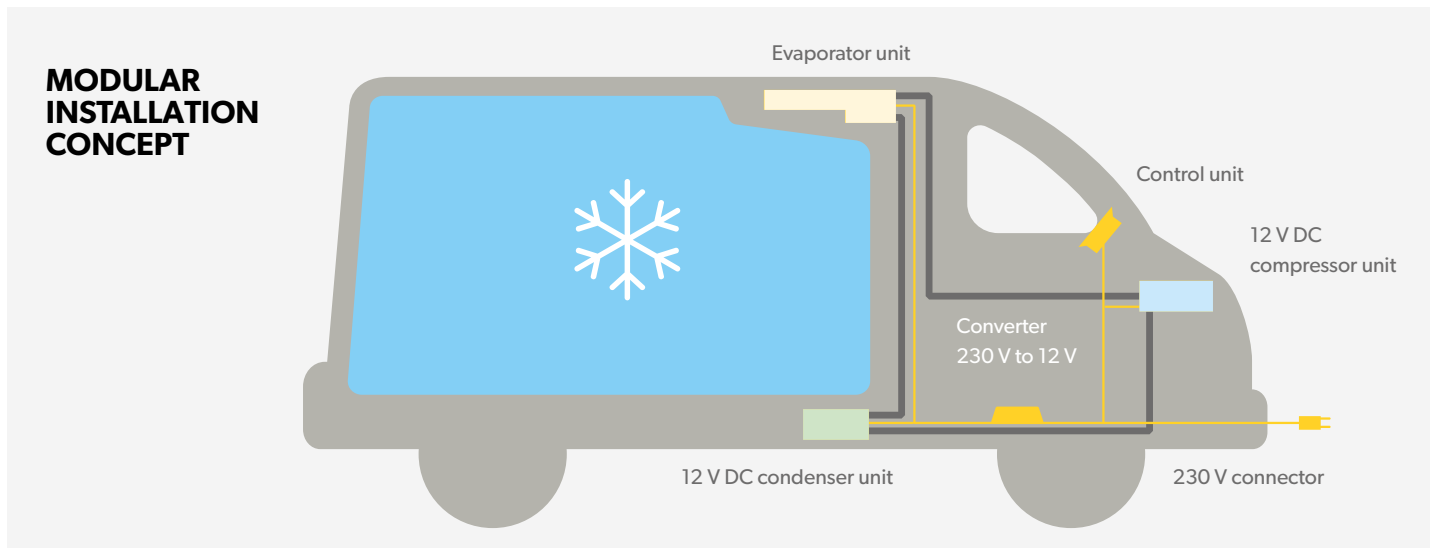

## COMPONENTS CAN BE COMBINED FOR ANY APPLICATION

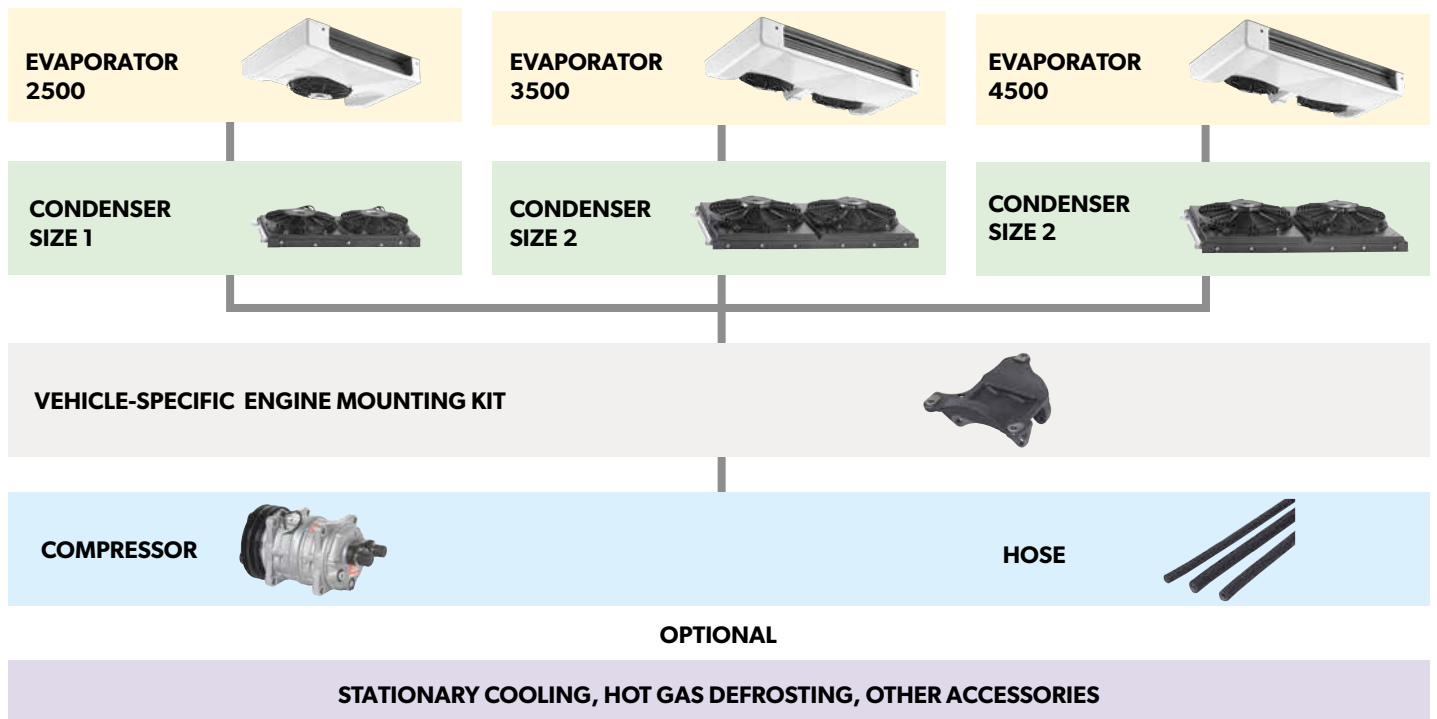

# PRODUCT SELECTION

Operation performance according to ATP regulations with 3 door openings per hour at 30 °C outside temperature

**NEW**  
Dometic Frigo  
DC 2500

**NEW**  
Dometic Frigo  
DC 3500

Capacity  
cargo room

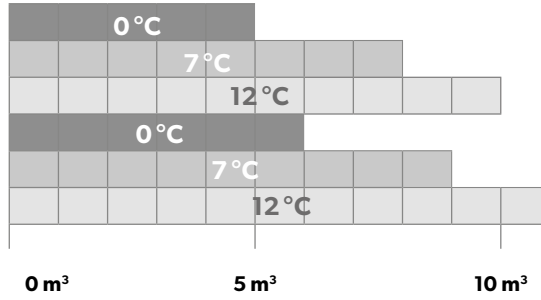

**R134a**

- 12°C
- 7°C
- 0°C

Specifications for R134a: k-value = 0.4 W (m² K) with 3 door openings of 3 minutes each per hour, ambient temperature 30°C, relative air humidity 60% (DIN 1815)

Dometic Frigo 2500  
Dometic Frigo 3500  
Dometic Frigo 4500

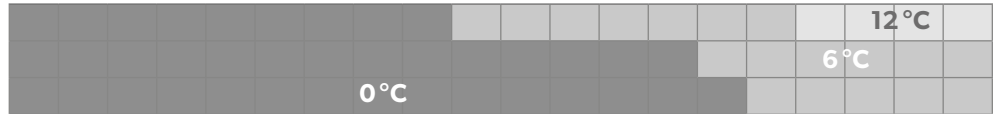

Dometic Frigo 2500  
Dometic Frigo 3500  
Dometic Frigo 4500

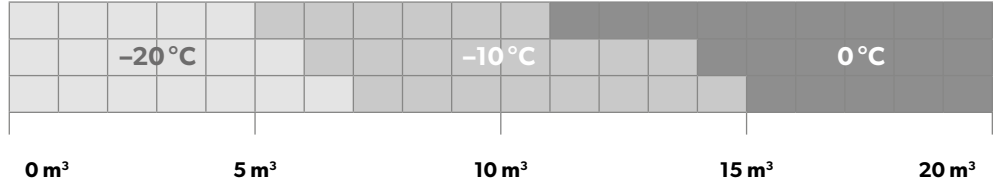

- R 134a**
- 12°C
  - 6°C
  - 0°C
- R 404a**
- 0°C
  - -10°C
  - -20°C

Specifications for R134a: k-value = 0.7 W (m² K) with 3 door openings of 3 minutes each per hour, ambient temperature 30°C, relative air humidity 60% (DIN 1815)  
Specifications for R404a: k-value = 0.4 W (m² K) with 3 door openings of 3 minutes each per hour, ambient temperature 30°C, relative air humidity 60% (DIN 1815)

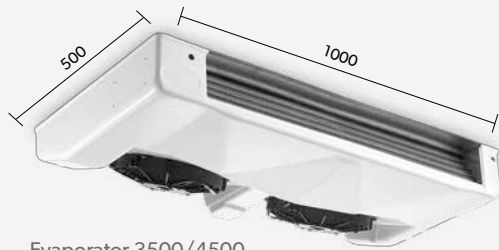

Evaporator 3500/4500

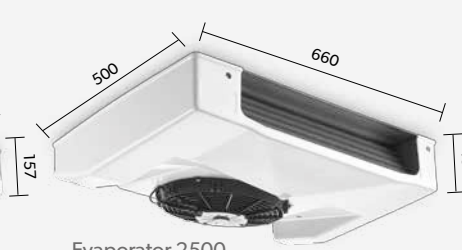

Evaporator 2500



Dometic Frigo DC Control unit (Dometic Frigo DC only)



Condenser 3500/4500



Condenser 2500



Dometic Frigo DC Compressor-condenser (Dometic Frigo DC only)



## INFO

The Dometic Frigo control unit displays when service is due. The cooling system will keep running, though. The calculation of the operating hours is based on the time the compressor is in operation. Service is due after the first 100 operating hours after the cooling system's initial start-up, and then every 1,000 operating hours.

# UNIQUE TECHNICAL DETAILS DOMETIC FRIGO EXCELS WITH QUALITY

Performance, efficiency, durability, ease of installation and ease of maintenance: these are the requirements to be met by the designers of fully integrated cooling systems. Here are just a few technical details where Dometic Frigo systems make a difference.

## MULTI-POINT REFRIGERANT INJECTION

Dometic Frigo systems owe their excellent cooling performance to a multi-point injection system and the use of evaporators with optimised capacity. The multi-point injection system ensures that the refrigerant is evenly distributed in the evaporator. This, in turn, results in a homogenous evaporation process and improves the cooling performance.



Optimised cooling: the multi-point injection system on the evaporator improves the distribution of the refrigerant.

## FILTER DRIER WITH SIGHT GLASS

Another beneficial detail is the filter drier with the integrated sight glass, which makes it easy to monitor the fill level and condition of the refrigerant. A single glance on the sight glass is enough to know when the drier needs to be replaced. Damage to the system or downtimes can be effectively avoided. (Dometic Frigo only)

## SPLASH-PROOF COMPONENTS

Quality is also the hallmark of the Stand-by cooling system. Dometic is the only manufacturer to offer a splash-proof 230-volt connection to be fitted on the bumper, a patented solution from DEFA.



Optimised check-up: the sight glass on the filter drier allows you to monitor the cooling system (Dometic Frigo only)



## PROFESSIONAL COOLING

### DOMETIC FRIGO REFRIGERATION SYSTEMS

ATP  
+ DIN 8958  
certified  
according to require-  
ments of the HACCP  
guidelines.

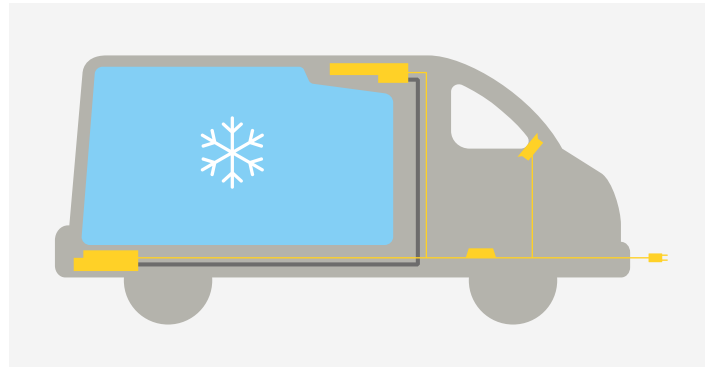

## CERTIFIED REFRIGERATION FOR RELIABLE COLD CHAIN MANAGEMENT

Companies transporting foodstuffs or other temperature-sensitive products have to meet strict legal requirements. They are responsible for ensuring that the cold chain is maintained throughout the product's way to the consumer. No problem – Dometic Frigo cooling systems for refrigerated vehicles are 100 % reliable. Our systems are ATP-approved and certified to DIN 8958, a standard regulating the performance and functioning of cooling systems for thermally insulated means of transportation. Customers can be sure they can transport their sensitive freight safely and reliably at all times.

Read more on this on page 14.

## FULLY INTEGRATED COOLING – NO ROOF-MOUNT STRUCTURE

Dometic Frigo refrigeration systems give you the unique benefit of fully integrated installation. The evaporator unit is fitted to the ceiling of the cargo compartment in a space-saving manner. It's never in the way – neither during loading and unloading, nor during clean-up. Unlike with other manufacturers' systems, there's no roof-mounted structure. **That means:**

- No problems with headroom restrictions, e.g. in underground car parks
- Safer driving even in tricky situations, because the vehicle's centre of gravity remains unchanged
- No roof cut-out required – the chassis' stability and anti-corrosion properties are preserved
- No impairment of the vehicle's appearance and aerodynamics



## STAND-BY COOLING OPTION FOR DOMETIC FRIGO

The optional stand-by cooling kit optimises the logistic workflow. The vehicle can be loaded or remain loaded overnight so as to be ready in the morning to get on its way. There is no need to store the goods temporarily in a stationary cooling room. The compressor of the stand-by cooling kit is installed in the driver's cab underneath the seat; a 230 V external socket for connecting the system is built into the front bumper. As the cooling components of the installation are also supplied with on-board current in stationary mode, we have added a high-quality IUOU charger which ensures the vehicle battery is properly charged.



## HOT GAS DEFROSTING AS STANDARD OR OPTIONAL

Problems with long idle times when the evaporator is iced and needs to be thawed? Simply activate the Dometic Frigo hot gas defrosting system to get your vehicle back on the road in no time at all. It heats up the refrigerant between the compressor and evaporator and thaws the evaporator quickly, so it can work with full efficiency again.

**Hot gas defrosting is included as standard on Dometic Frigo DC systems, but optional on the Dometic Frigo version.**



# REFRIGERATION AND DEEP-FREEZE CONTAINERS ALSO AVAILABLE

**TOP LOADING OF FRONT LOADING FROM 200 L UP TO 1000 L  
FOR MORE INFORMATION PLEASE CONTACT A DOMETIC REPRESENTATIVE**

You want to create a separate freezer area in the refrigerated vehicle or also want to transport fresh goods in a freezer vehicle? Then you should take a look at the new cooling containers from Dometic. They come in six varieties: front or top loading, each in three different sizes. The top-loading containers, which can also freeze products, allow you to switch between two set temperatures: +4 °C or -18 °C.

The temperature is set as standard to +4 °C on all front loaders. Practical details such as easy-to-operate slide doors, pallet feet and transport rollers (accessories) ensure comfortable handling. The optional battery set can retain the set temperature for up to 8 hours without an external power supply.

## FRONT LOADER (+4 °C FIXED TEMPERATURE)

## TOP LOADER (+4 °C / -18 °C FIXED TEMPERATURE)

- A factory-set fixed temperature: +4 °C
- Frontloading, top can be used for storage
- Heavy-duty design – rugged, long-life
- Pallet feet for safe loading and unloading with fork-lifts
- Attachments to tie the box safely down in the vehicle
- Customer-specific accessories (e.g. battery set, transport rollers, data logger, smartphone app)

- Two factory-set fixed temperatures: +4 °C / -18 °C
- Toploading, minimum refrigeration losses
- Heavy-duty design – sturdy with long life expectancy
- Pallet feet for secure loading and unloading with fork-lifts
- Attachments to tie the box safely down in the vehicle
- Customer-specific accessories (e.g. battery set, transport rollers, data logger, smartphone app)



Independent energy supply: The optional battery set ensures a constant cooling temperature for up to 8 hours (at an external temperature of 32 °C), without an external power supply.

# APPROVALS AT A GLANCE



## ATP

ATP is an international agreement that covers the rules and standards for the transportation of perishable foodstuffs. In essence, ATP defines the technical requirements to the special equipment used for cross-border carriage of foodstuffs. Strictly defined type approvals or individual testing are used to find out whether a specific cooling system is suitable for food transport according to ATP. The findings are documented in a test protocol.

## DIN 8958

DIN 8958 defines the technical requirements to cooling equipment used in insulated means of transportation. It also describes the test methods to be applied to measure the system's performance. The standard considers the various types of cooling equipment.

A blue rectangular logo with white text that reads "HACCP GUIDELINES".

**HACCP  
GUIDELINES**

## HACCP

„HACCP stands for “Hazard Analysis Critical Control Points”, a quality management concept for the production of foodstuffs. During production, the quality of foodstuffs can be impaired by biological, physical or chemical hazards. The HACCP system helps identify the critical points in the manufacturing process and have them under control. As a result, health risks for consumers can be systematically avoided. HACCP is integrated in European Council Directive 93/43/EEC as a preventive system for food hygiene.



Dometic is a global company that makes mobile living easy – by providing great solutions to satisfy people’s essential needs when they are on the move. Like cooking, taking care of personal hygiene and maintaining a pleasant temperature. We offer smart and reliable products with outstanding design.



#### AUSTRALIA

##### DOMETIC AUSTRALIA PTY. LTD.

1 John Duncan Court  
Varsity Lakes QLD 4227  
Tel +61 7 55076000  
Fax +61 7 55076001  
Mail sales@dometic-Domestic.com.au

#### AUSTRIA

##### DOMETIC AUSTRIA GMBH

Neudorferstrasse 108  
A-2353 Guntramsdorf  
Tel +43 2236 908070  
Fax +43 2236 90807060  
Mail info@dometic.at

#### BELGIUM

##### DOMETIC BRANCH OFFICE BELGIUM

Lourdesstraat 84  
B-8940 Geluwe  
Tel +32 2 3598040  
Fax +32 2 3598050  
Mail info@dometic.be

#### BRAZIL

##### DOMETIC DO BRASIL LTDA

Avenida Paulista 1754, conj. 111  
SP 01310-920 Sao Paulo  
Tel +55 11 3251 3352  
Tel +55 11 3251 3362  
Mail info@dometic.com.br

#### DENMARK

##### DOMETIC DENMARK A/S

Nordensvej 15, Taulov  
DK-7000 Fredericia  
Tel +45 75585966  
Fax +45 75586307  
Mail info@dometic.dk

#### FINLAND

##### DOMETIC FINLAND OY

Mestarintie 4  
FIN-01730 Vantaa  
Tel +358 20 7413220  
Mail info@dometic.fi

#### FRANCE

##### DOMETIC SAS

ZA du Pré de la Dame Jeanne  
B.P. 5  
F-60128 Plailly  
Tel +33 3 44633525  
Fax +33 3 44633518  
Mail automotive@dometic.fr

#### GERMANY

##### DOMETIC DOMETIC INTERNATIONAL GMBH

Hollefeldstraße 63  
D-48282 Emsdetten  
Tel +49 (0) 2572 879-0  
Fax +49 (0) 2572 879-300  
Mail info@dometic-Domestic.de

#### HONG KONG

##### DOMETIC GROUP ASIA PACIFIC

Suites 2207-11, 22/F, Tower 1  
The Gateway, 25 Canton Road  
Tsim Sha Tsui, Kowloon  
Tel +852 2 4611386  
Fax +852 2 4665553  
Mail info@Dometic.com.hk

#### HUNGARY

##### DOMETIC ZRT. SALES OFFICE

H-1147 Budapest  
Kerekgyártó and 5.  
Tel +36 1 468 4400  
Fax +36 1 468 4401  
Mail budapest@dometic.hu

#### ITALY

##### DOMETIC ITALY S.R.L.

Via Virgilio, 3  
I-47122 Forlì (FC)  
Tel +39 0543 754901  
Fax +39 0543 754983  
Mail vendite@dometic.it

#### JAPAN

##### DOMETIC KK

Maekawa-Shibaura, Bldg. 2  
2-13-9 Shibaura Minato-ku  
Tokyo 108-0023  
Tel +81 3 5445 3333  
Fax +81 3 5445 3339  
Mail info@dometic.jp

#### MEXICO

##### DOMETIC MX, S. DE R. L. DE C. V.

Circuito Médicos No. 6 Local 1  
Colonia Ciudad Satélite  
CP 53100 Naucalpan de Juárez  
Estado de México  
Tel +52 55 5374 4108  
Fax +52 55 5393 4683  
Mail info@dometic.com.mx

#### NETHERLANDS

##### DOMETIC BENELUX B.V.

Ecustraet 3  
NL-4879 NP Etten-Leur  
Tel +31 76 5029000  
Fax +31 76 5029019  
Mail info@dometic.nl

#### NEW ZEALAND

##### DOMETIC NEW ZEALAND LTD.

PO Box 12011  
Penrose  
Auckland 1642  
Tel +64 9 622 1490  
Fax +64 9 622 1573  
Mail customerservices@dometic.co.nz

#### NORWAY

##### DOMETIC NORWAY AS

Østerøyveien 46  
N-3236 Sandefjord  
Tel +47 33428450  
Fax +47 33428459  
Mail firmapost@dometic.no

#### POLAND

##### DOMETIC POLAND SP. Z O.O

ul. Puławska 435A  
PL-02-801 Warszawa  
Tel +48 22 414 3200  
Fax +48 22 414 3201  
Mail info@dometic.pl

#### PORTUGAL

##### DOMETIC SPAIN, S.L.

Branch Office em Portugal  
Rot. de São Gonçalo nº 1- Esc. 12  
2775-399 Carcavelos  
Tel +351 219 244 173  
Fax +351 219 243 206  
Mail info@dometic.pt

#### RUSSIA

##### DOMETIC RUS LLC

Komsomolskaya square 6-1  
RU-107140 Moscow  
Tel +7 495 780 79 39  
Fax +7 495 916 56 53  
Mail info@dometic.ru

#### SINGAPORE

##### DOMETIC PTE LTD

18 Boon Lay Way  
06-141 Trade Hub 21  
Singapore 609966  
Tel +65 6795 3177  
Fax +65 6862 6620  
Mail dometic@dometic.com.sg

#### SLOVAKIA & CZECH REPUBLIC

##### DOMETIC SLOVAKIA S.R.O.

Sales Office Bratislava  
Nádražná 34/A  
900 28 Ivanka pri Dunaji  
Tel +421 2 45 529 680  
Fax +421 2 45 529 680  
Mail bratislava@dometic.com

#### SOUTH AFRICA

##### DOMETIC (PTY) LTD.

Regional Office South Africa &  
Sub-Saharan Africa  
2 Avalon Road, West Lake View  
Ext 11, Modderfontein 1645  
Tel +27 87 3530380  
Mail info@dometic.co.za

#### SPAIN

##### DOMETIC SPAIN S.L.

Avda. Sierra del Guadarrama, 16  
E-28691 Villanueva de la Cañada  
Madrid  
Tel +34 91 833 6089  
Fax +34 900 100 245  
Mail info@dometic.es

#### SWEDEN

##### DOMETIC SCANDINAVIA AB

Gustaf Melins gata 7  
SE-421 31 Västra Frölunda  
Tel +46 31 7341100  
Fax +46 31 7341101  
Mail info@dometicgroup.se

#### SWITZERLAND

##### DOMETIC SWITZERLAND AG

Riedackerstrasse 7a  
CH-8153 Rümlang  
Tel +41 44 8187171  
Fax +41 44 8187191  
Mail info@dometic.ch

#### UNITED ARAB EMIRATES

##### DOMETIC MIDDLE EAST FZCO

P.O. Box 17860  
S-D 6, Jebel Ali Freezone  
Dubai  
Tel +971 4 883 3858  
Fax +971 4 883 3868  
Mail info@dometic.ae

#### UNITED KINGDOM

##### DOMETIC UK LTD.

Domestic House, The Brewery,  
Blandford St. Mary  
Dorset DT11 9LS  
Tel +44 344 626 0133  
Fax +44 344 626 0143  
Mail info@dometic.co.uk